

ASSEMBLY INSTRUCTIONS

MERCEDES SPRINTER 170" CARGO

This document presents the detailed procedures for assembling Legend Fleet components and accessories.

Customers can make use these step-by-step procedures and easily assemble without major difficulty.



LEGEND
FLEET SOLUTIONS

519 688 1043
customercare@legendfleet.com

56957 HWY 3 WEST,
TILLSONBURG,
ON N4G 4G8.

Table of Contents

Wheel Well Cover.....	3
Floor.....	4
Floor Sills	8
Wall Liners	10
Ceiling Liners.....	13
Top Sills.....	17
Door Liners	21

Wheel Well Cover

Parts and Hardware

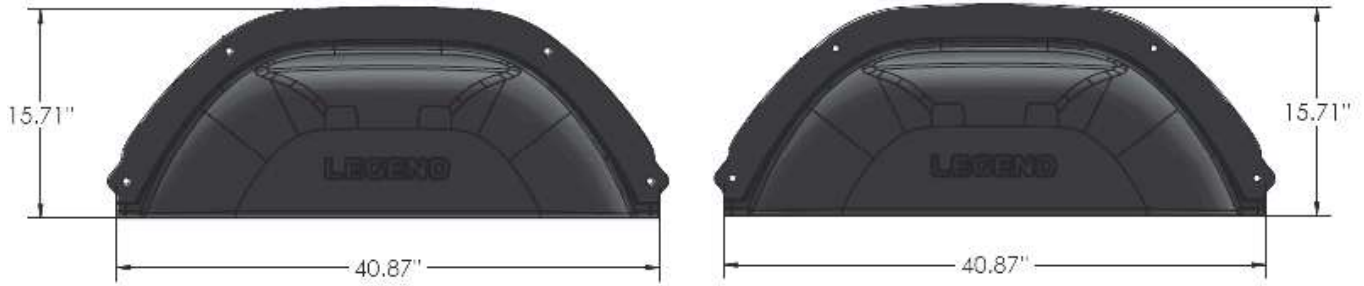

DRIVER SIDE'S WHEEL WELL COVER

PASSENGER SIDE'S WHEEL WELL COVER

8 x



PUSH-IN RIVET

Assembly Instructions

Floor and Wall liner must be installed after the installation of Wheel well covers

Step 1: Place the **Driver side** and **Passenger side** wheel well covers in the vehicle, as shown below.

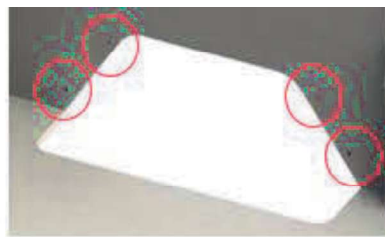
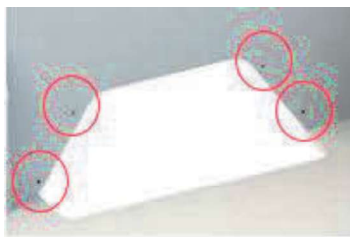

"positioning of Passenger side WWC"

"positioning of Driver side WWC"

8 x



Floor

Parts and Hardware



1 x



FRONT RAIL JOINT (59.35")

1x



REAR RAIL JOINT (70.00")

10 x



M8 BOLT

10 x



M8 FLAT WASHER

1 x



GLUE

6 x



Spacers

Install the provided spacers across the cavities as shown below

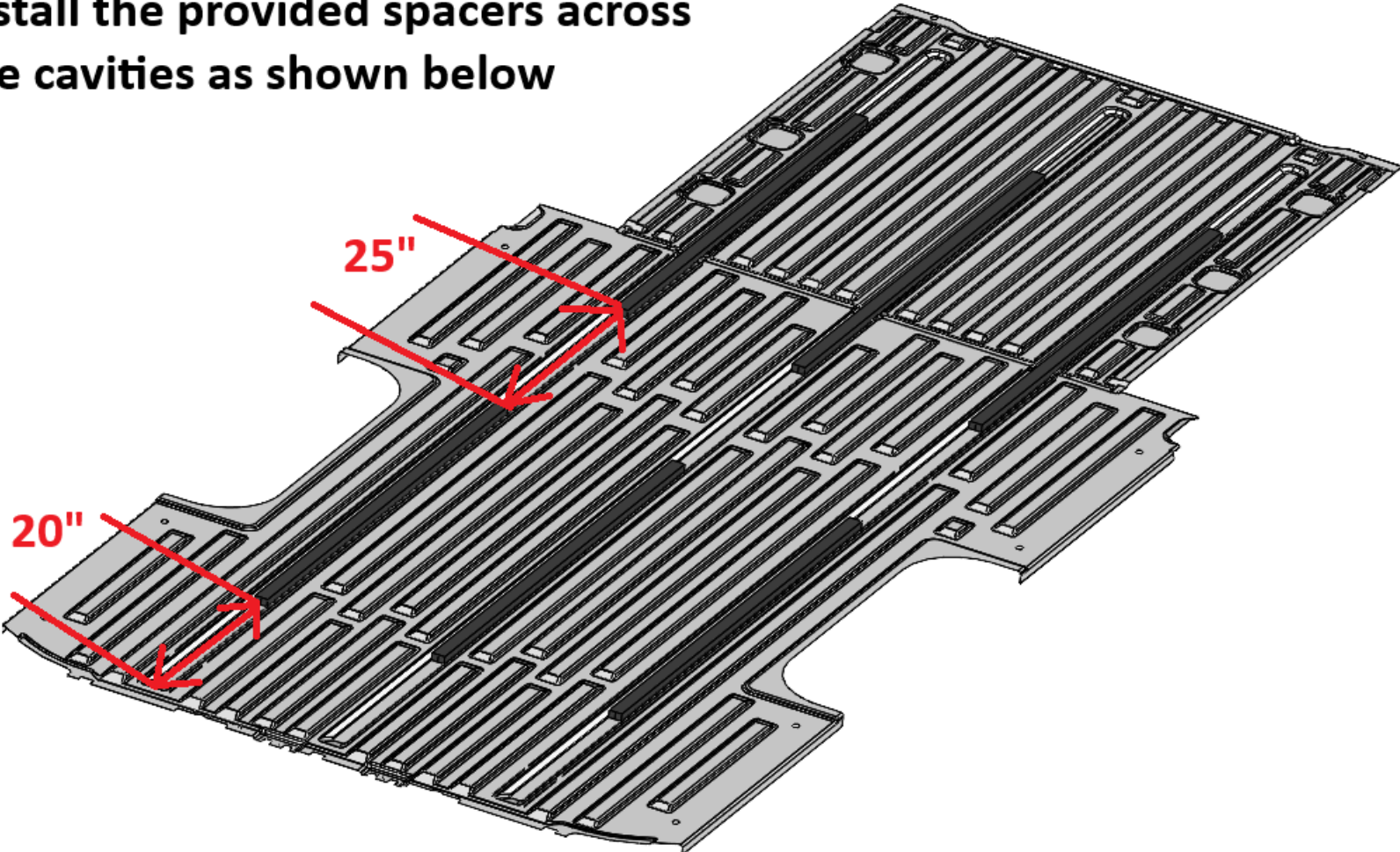

Assembly instructions

Remove the following items before floor installation:

1. OEM Plastic Trim
2. D-Rings
3. Tie-Downs
4. Other installed parts

Apply a thin line of glue in both the grooves of the Rail Joints, that is supplied with Legend's floor.

Step 1: Install Floor Piece A, as shown below.



Figure 1

Step 2: Install the Parts in the following order after installing Floor Piece A. as shown below.

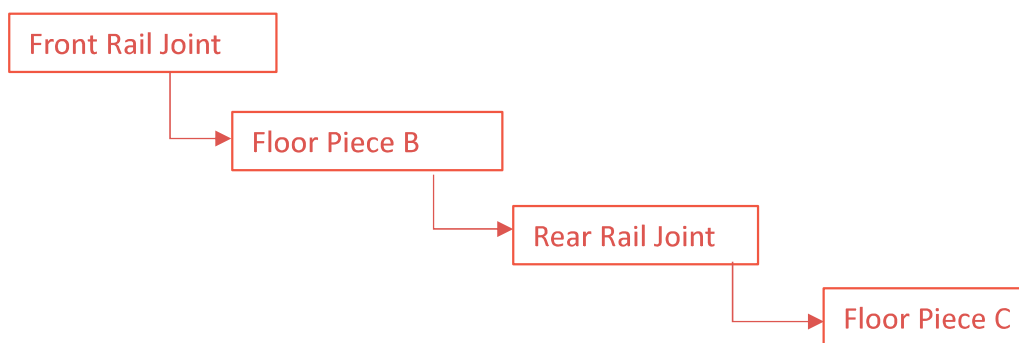

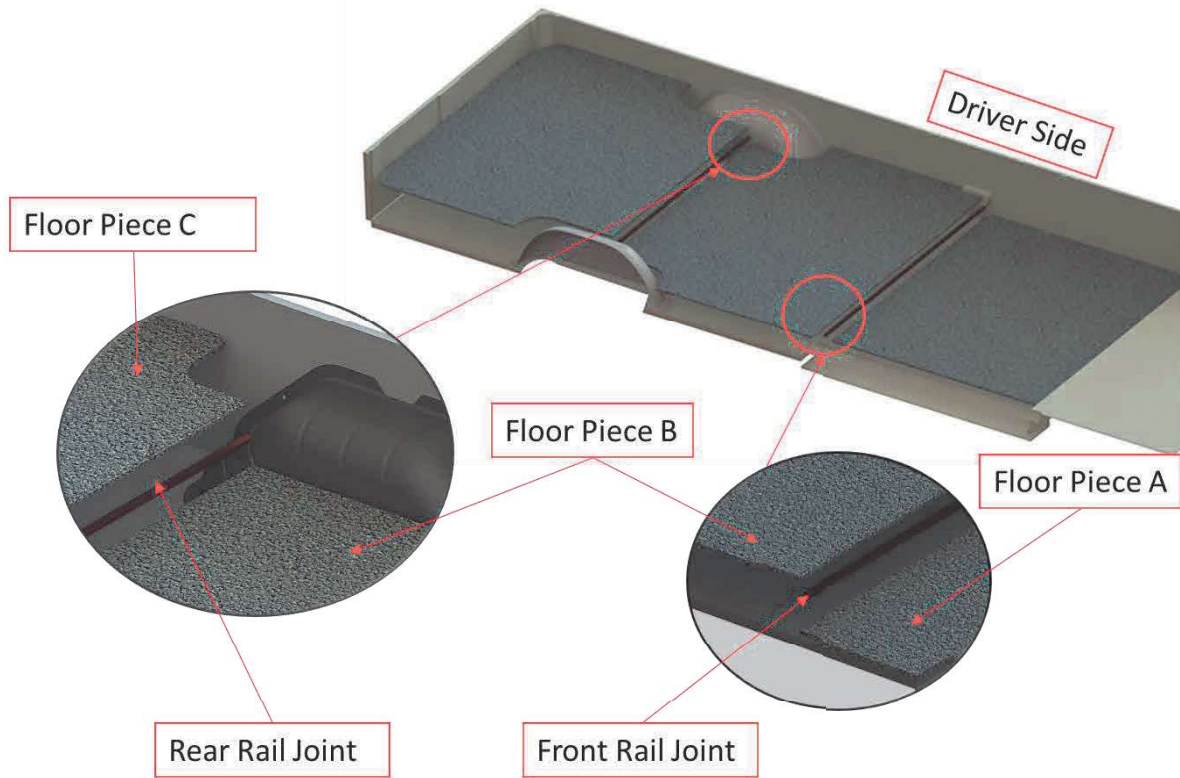

Figure 2

Step 3: Replace the OEM bolt in each D-Ring with combination of M8 Bolt and a flat washer as shown below.



Figure 3

Step 4: Completing the installation of your Legend Floor

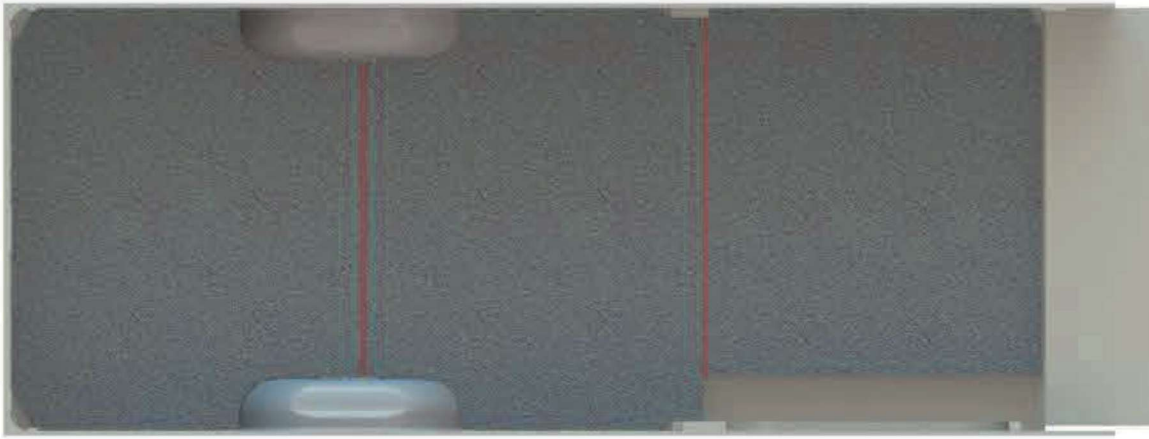

Figure 4

“Floor Installed” This view is from Inside of Van-Viewing from Top

Floor Sills

Parts and Hardware



Assembly Instructions

Step 1: Position the Side Sill on Legend’s Floor. Place the Pan Head Screws (3 Nos) to the Floor as shown below

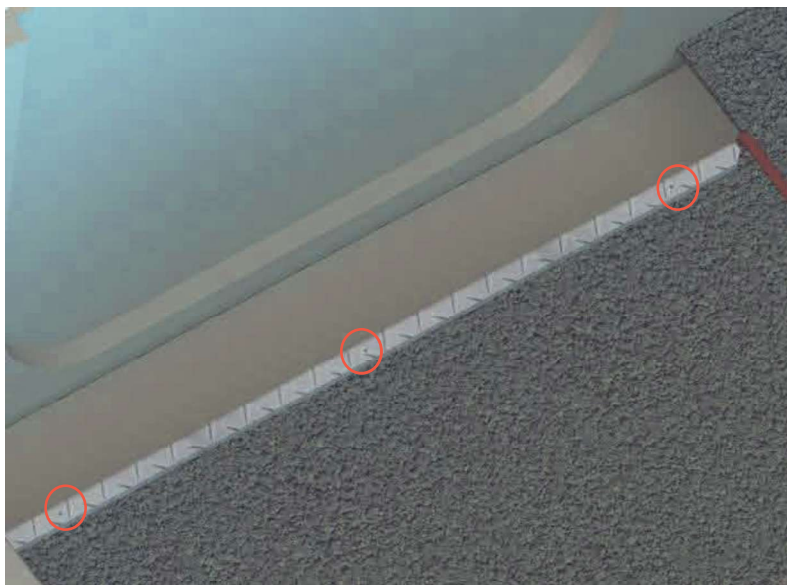
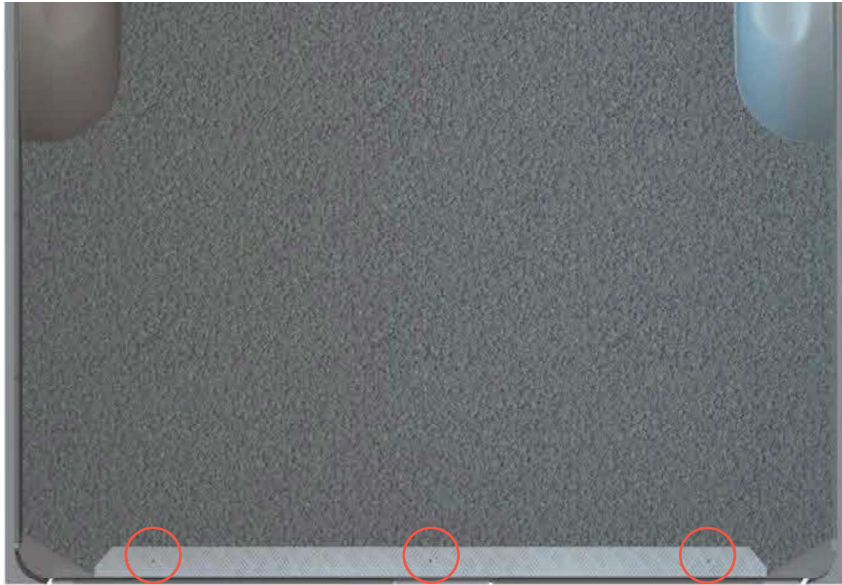

Figure 5
 “Positioning and Fixing of the Side Sill”

Step 2: Position the Rear Sill on Legend's Floor.

Driver Side



Passenger Side

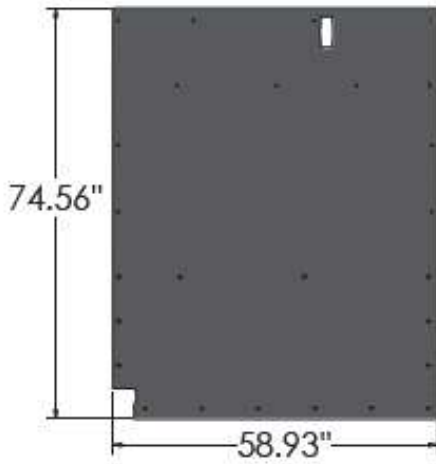

Figure 6

"Positioning and Fixing of the Rear Sill"

Wall Liners

Parts and Hardware



DRIVER SIDE FRONT WALL (D1A)

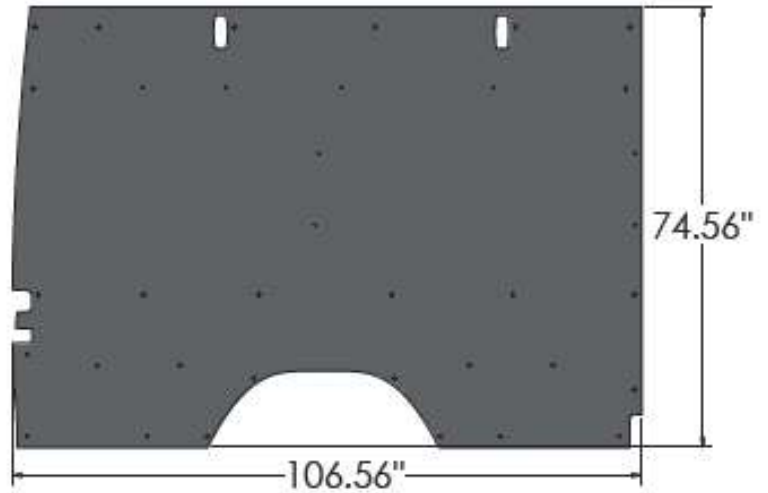

DRIVER SIDE REAR WALL (D2A)

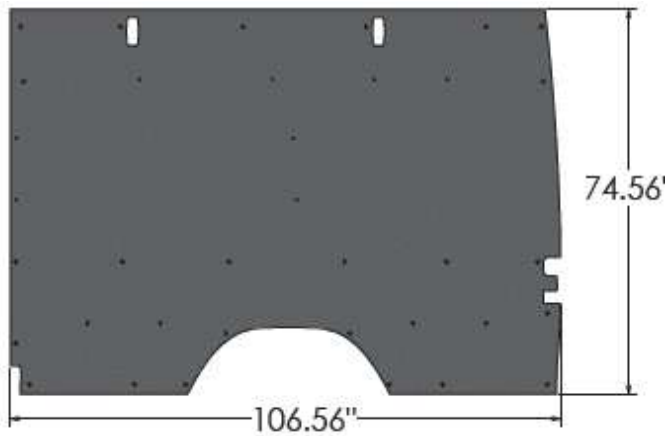

PASSENGER SIDE FRONT WALL (P1A)

72 x



PUSH-IN RIVET

28 x



SCREW CAP

28 x



SELF-DRILLING SCREW

Assembly Instructions

If Legend's Wheel Well Covers are used, the Wall Liner will lay over the Top Flange of Wheel Well Cover.

Hole Diameter (\varnothing) = 0.40" = 

Hole Diameter (\varnothing) = 0.20" = 

Step 1: Bring the (D1A) Liner into the vehicle and align the holes on the panel with the ones present on the vehicle's body.

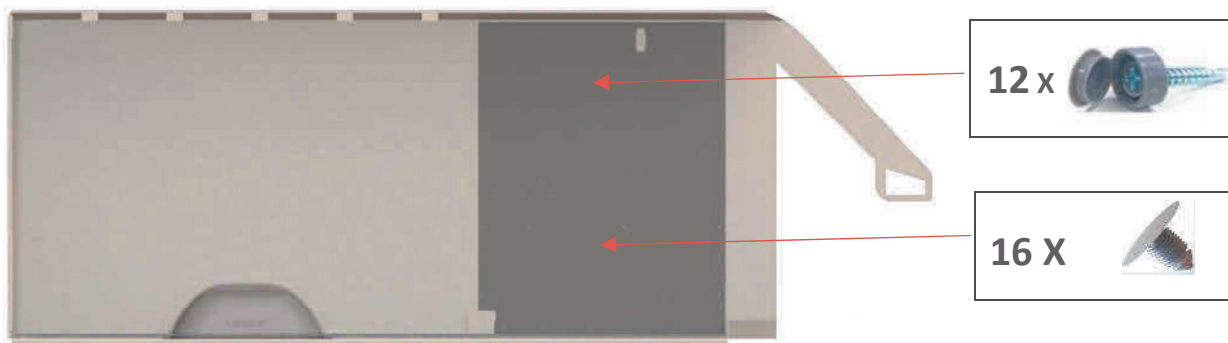

Figure 7

Step2: Bring the (D2A) Liner into the vehicle and align the holes on the panel with the ones present on the vehicle's body.

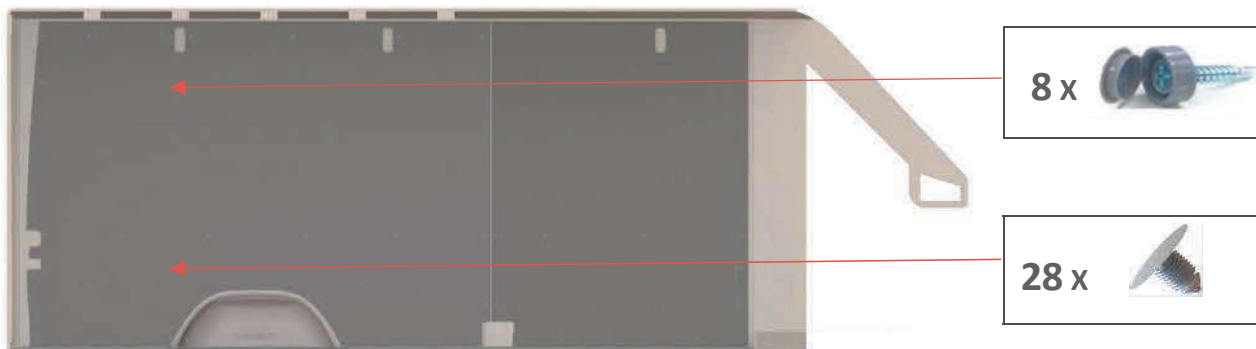

Figure 8

"Driver Side Front & Rear Wall Liner Installed" This is view from Inside of the Van- Viewing from Passenger Side

Step 3: Bring the (P1A) Liner into the vehicle and align the holes on the panel with the ones present on the vehicle's body.

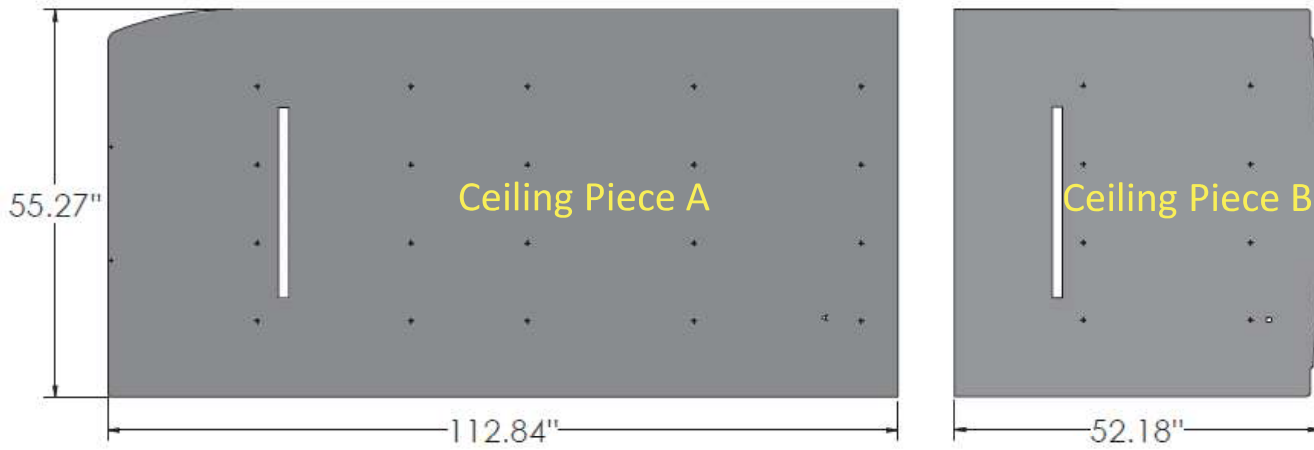

Figure 9

"Passenger Side Rear Wall Liner Installed" This is view from Inside of the Van- Viewing from Driver Side

Ceiling Liners

Parts and Hardware



CEILING PIECES

1 x



CEILING BRACKET

1 x



CEILING JOINER STRIP (55.25")

2 x



SCREW CAP

2 x



SELF-DRILLING SCREW

28 x



PUSH-IN RIVET

Assembly Instructions

Follow the below instructions for score lines on Rear surface of Ceiling Panel

Hole Diameter (ϕ) = 0.40" = 

Hole Diameter (ϕ) = 0.20" = 

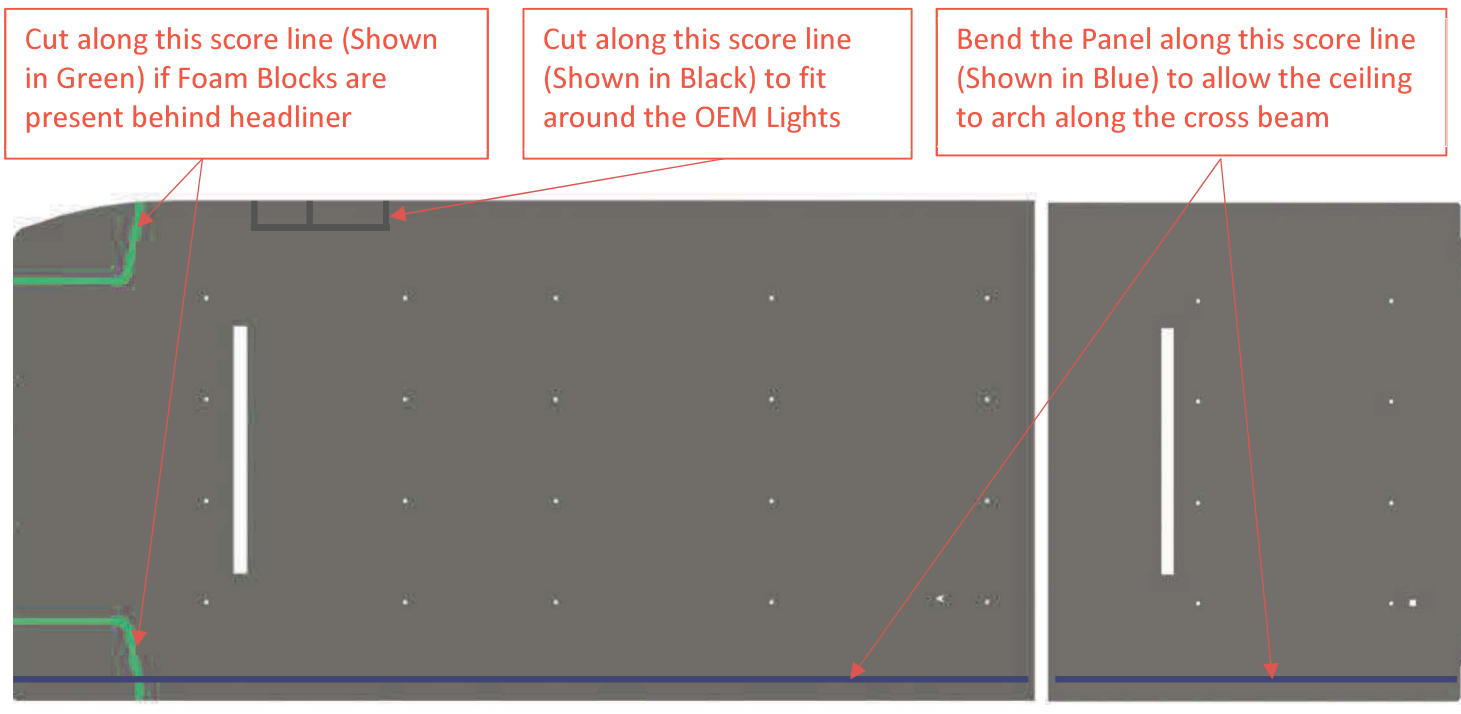

Step 1: Install Ceiling Bracket to the roof as shown below.

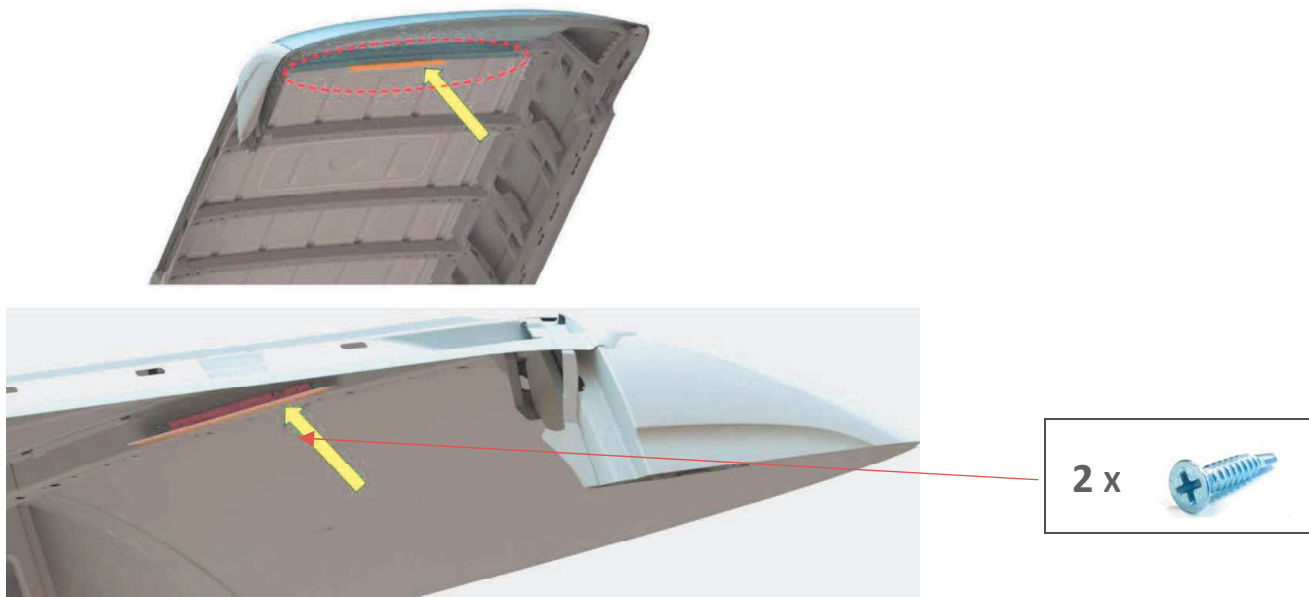

Figure 10

Step 2: Install Ceiling Piece A, as shown below.

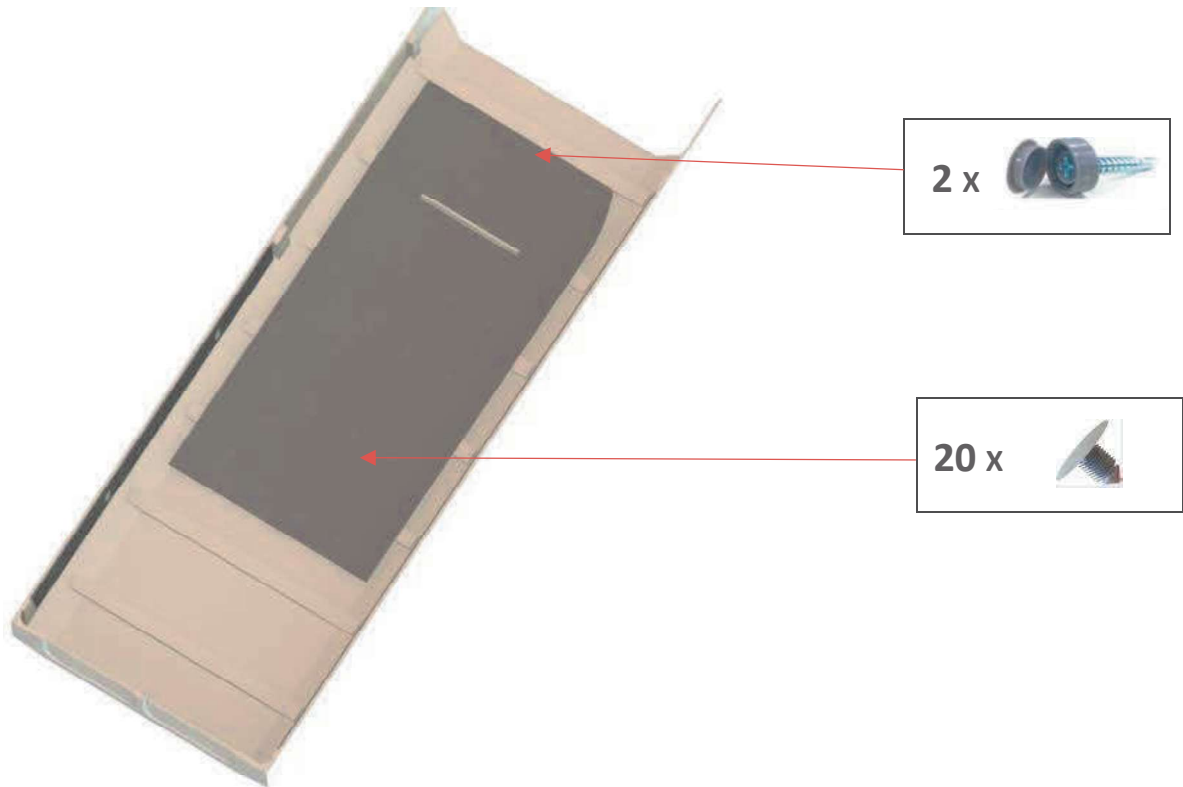

Figure 11

"Positioning and Fixing of the Ceiling Panel A" This View is from Inside of the Van

Step 3: Install the Ceiling Joiner strip at the edge of the Front Ceiling panel

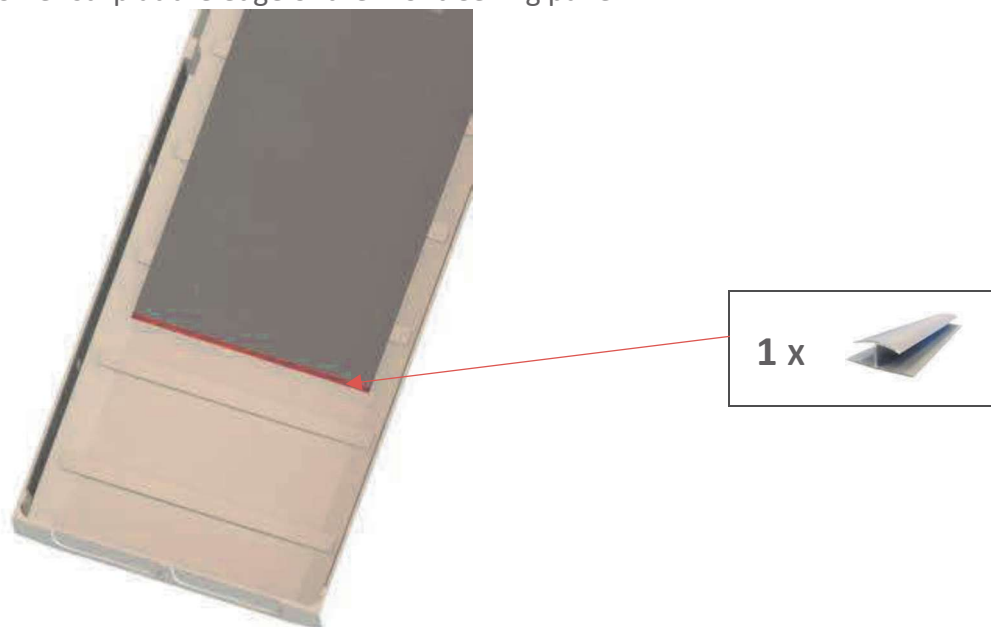

Figure 12

"Positioning and Fixing of the Ceiling Joiner Strip" This View is from Inside of the Van

Step 4: Install Ceiling Piece B, as shown below. Ceiling liner.

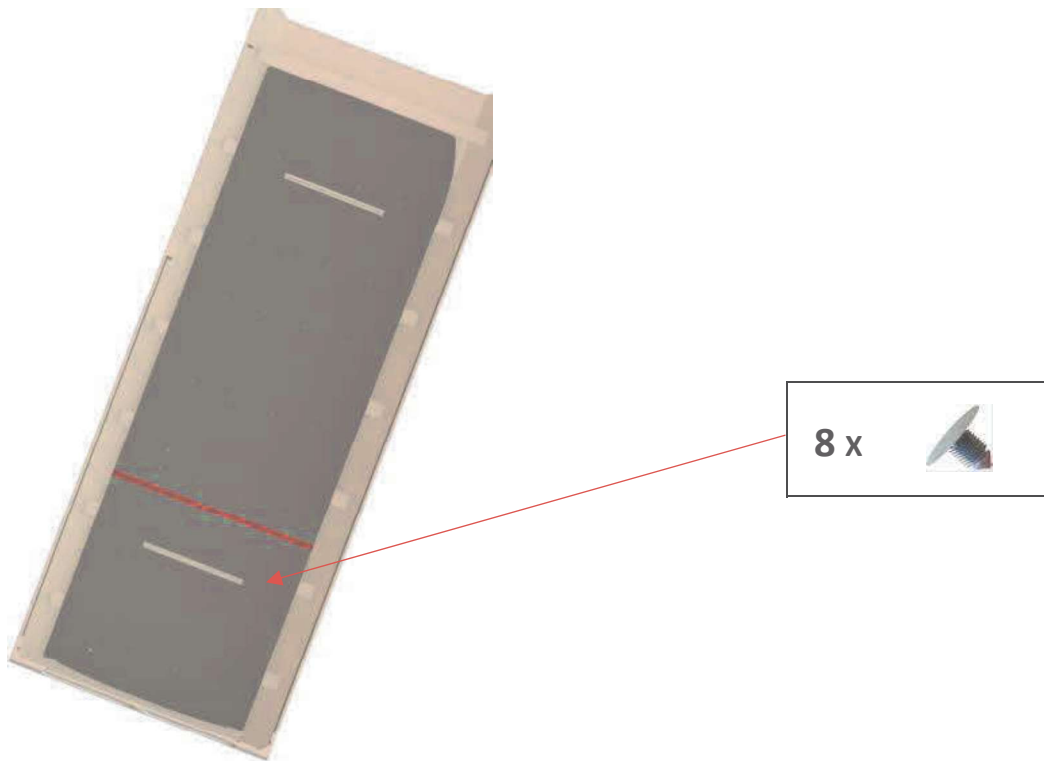

Figure 13

"Positioning and Fixing of the Ceiling Panel B" This View is from Inside of the Van

Step 5: This completes the installation of your Legend Ceiling Liner.

Top Sills

Parts and Hardware



Assembly Instructions

Assembly of the Top Sills is to be done outside of the Van before installing it in the Van.

Step 1: Assemble Driver Side sill – D1, E, F, F1 as shown below.

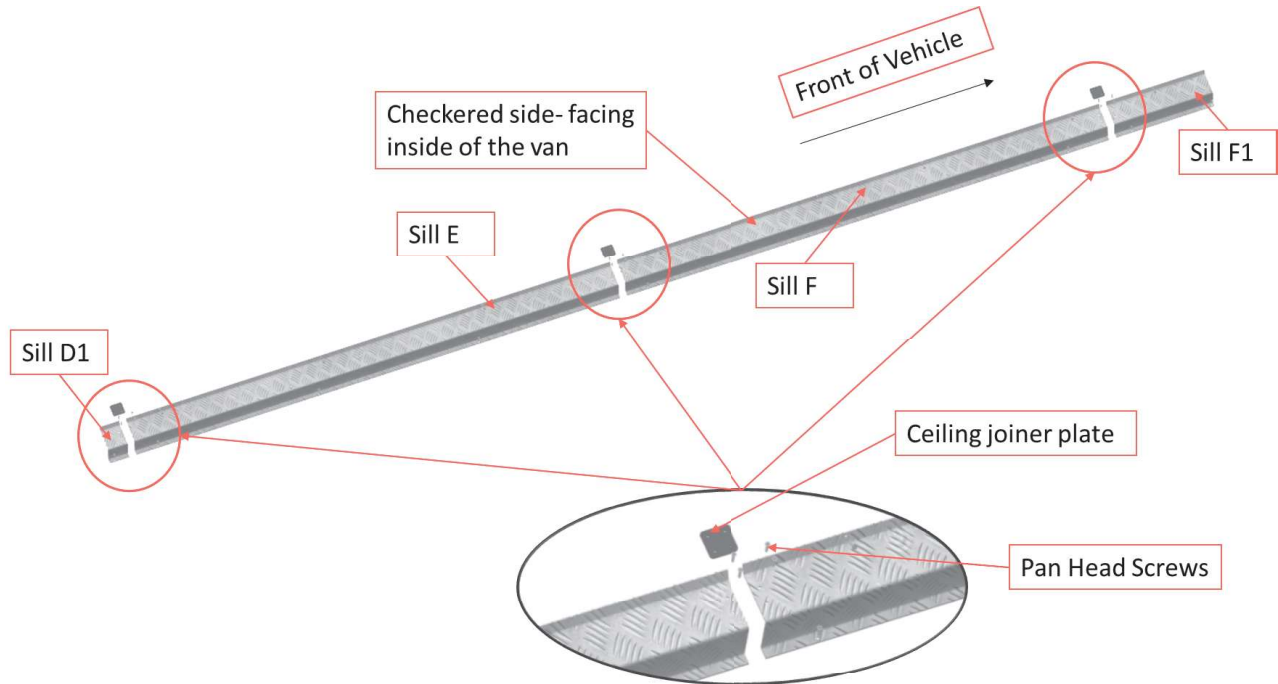

Figure 14

Note: 'Sill - F1' should not be installed when there are foam blocks by the B-Pillars (or, behind the driver and passenger seats).

Step 2: Fasten assembled sills in the Van.

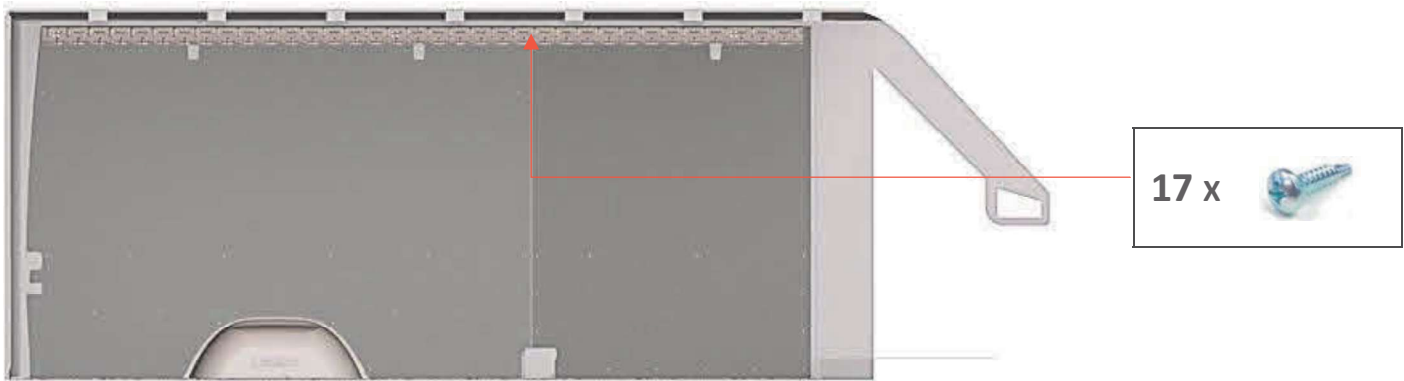

Figure 15
"Driver side Top Sills installed"

Step 3: Assemble Passenger Side Sill – A1, A, B, C, C1 as shown below.

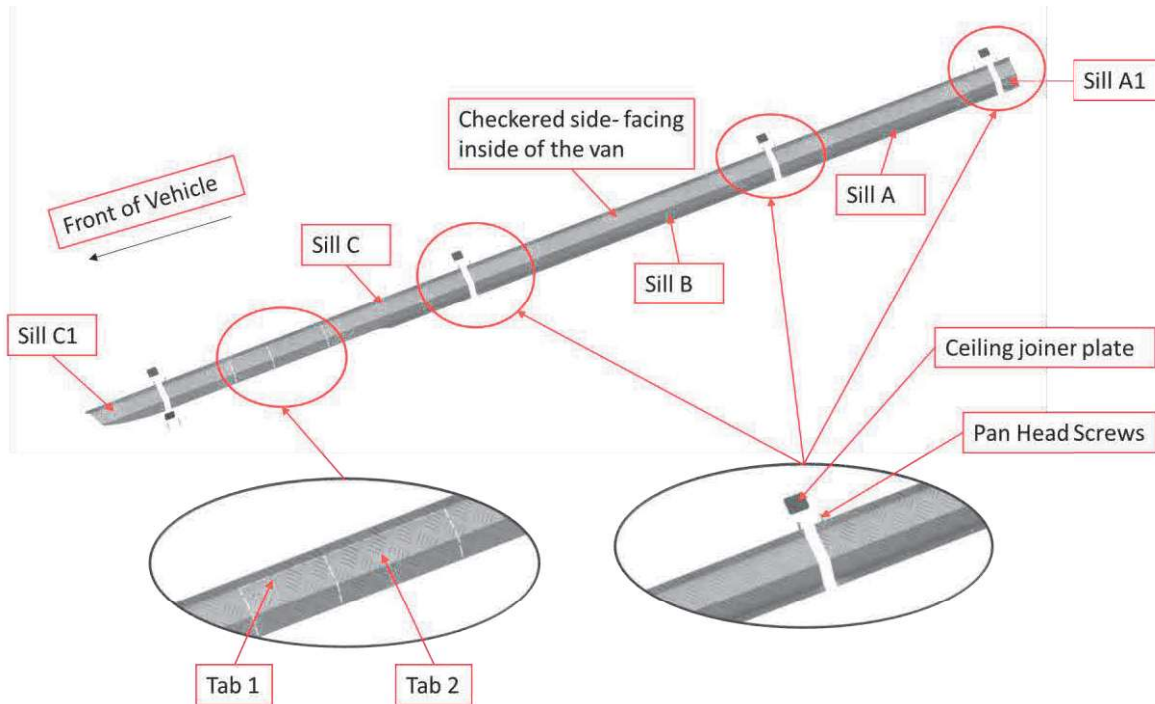

Figure 16

Note:

1. 'Sill - C1' should not be installed when there are foam blocks by the B-Pillars (or, behind the driver and passenger seats).
2. Sill C - Cut along tabs based on the presence of Rubber Block and/or Light present in the vehicle.
 Tab 1 – For Light
 Tab 2 - For Rubber Block



Figure 17

Step 4: Fasten assembled sills in the Van.

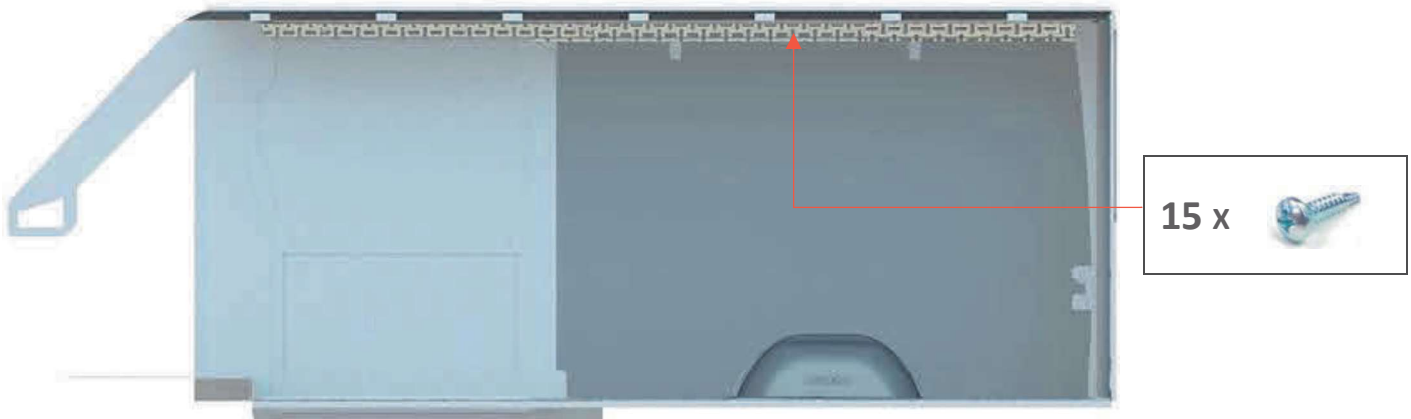
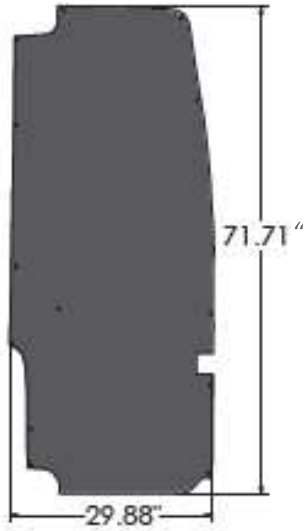

Figure 18
"Passenger side Top Sills installed"

Door Liners

Parts and Hardware



DRIVER SIDE REAR DOOR LINER(DRA)

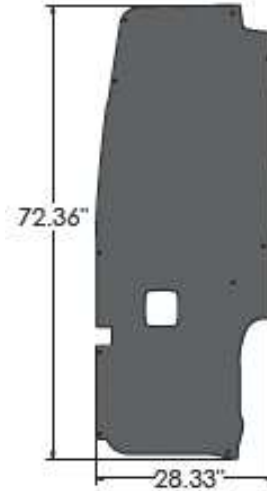

PASSENGER SIDE REAR DOOR LINER(PRA)

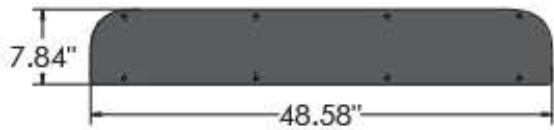

PASSENGER SIDE SLIDING DOOR LINER (PSC)

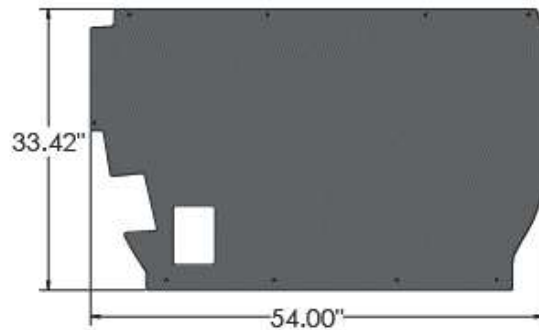

PASSENGER SIDE SLIDING DOOR LINER (PSB)

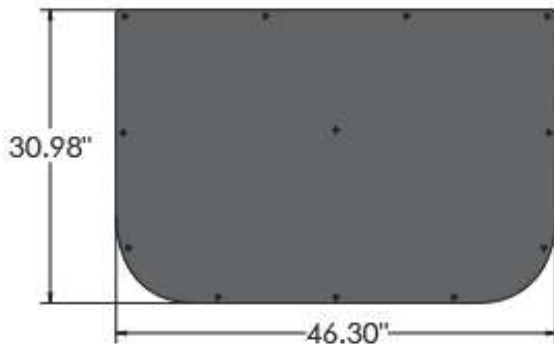

PASSENGER SIDE SLIDING DOOR LINER (PSA)

20 x



PUSH-IN RIVETS

33 x



SELF-DRILLING SCREW

33 x



SCREWCAP

Assembly Instructions

Van Doors MUST be in close Position When Installing Door Liners.

Hole Diameter (\varnothing) = 0.40" = 

Hole Diameter (\varnothing) = 0.20" = 

Step 1: Rear Door Assembly.

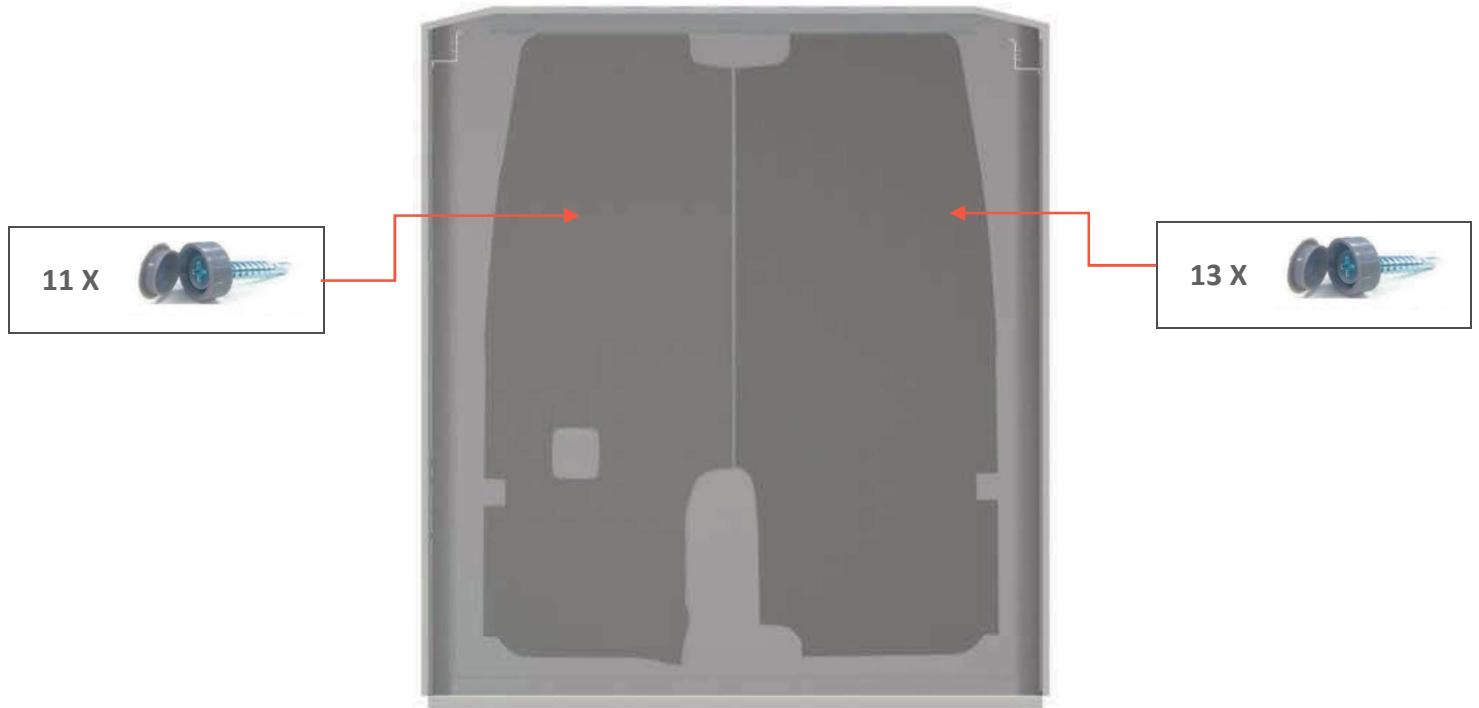

Figure 19
"Rear Door Liners Installed"

Step 2: Side Door Assembly.

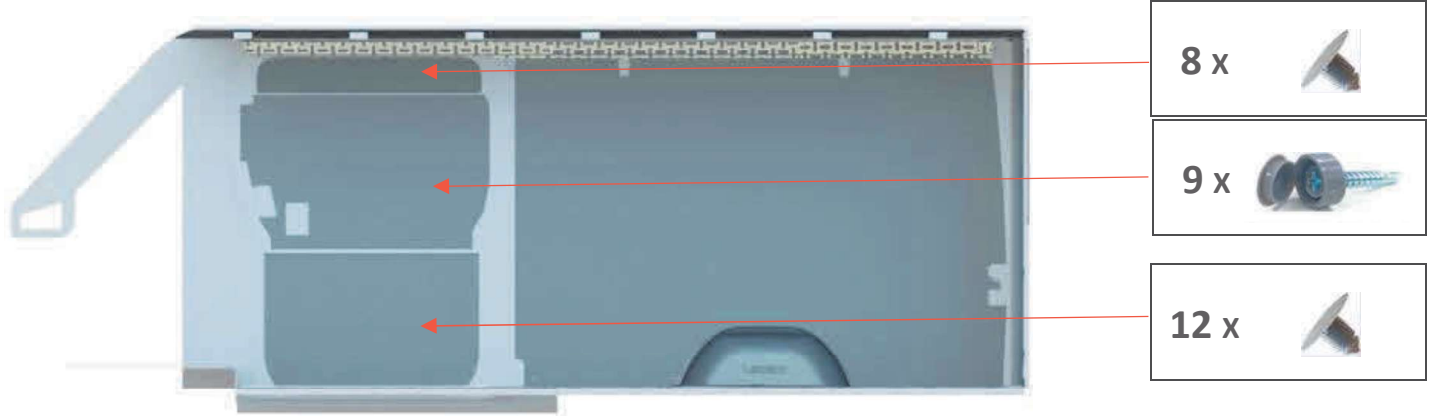

Figure 20

"Passenger Side Sliding Door Liner Installed"

Step 3: Installation of your Legend Door Liners is now complete.