

Rear View Mirror Monitor

 REPLACEMENT
MONITOR

 CLIP-ON MIRROR

Product Manual / Installation Instructions



Rear View Safety, Inc. © 2018

What's in the Box?

Note: System may be different based on item configuration

- 7" Color TFT LCD Digital Clip-on Mirror Monitor
- 1 Extension Cable for Camera
- 1 Remote Control
- 1 Power Connection Wire
- 1 Double RCA + Power Converter
(to connect external audio, video and power)
- 1 Screw Kit for Installation

Table of Contents

Introduction.....	4
Safety Information	5-7
Before Beginning Installation.....	8
Installation Guide.....	9
Wiring Camera & Monitor.....	10-11
Installation Diagram	12
Installing the Monitor	13
Monitor Operation	14
Splicing	15
Positioning	16
Monitor Dimensions.....	17
Monitor Specifications.....	18
Troubleshooting.....	19
Warranty.....	20
Disclaimer	21

Introduction

Please read all of the installation instructions carefully before installing the product. Improper installation will void manufacturer's warranty.

Congratulations on purchasing a Rear View Backup Camera System! With this manual you will be able to properly install and operate the unit.

The Backup Camera System is intended to be installed as a supplement aid to your standard rear view mirror that already exists in your vehicle. The Backup Camera System should not be used as a substitute for the standard rear view mirror or for any other mirror that exists in your vehicle.

In some jurisdictions, it is unlawful for a person to drive a motor vehicle equipped with a TV viewer or screen located forward of the back of the driver's seat or in any location that is visible, directly or indirectly, to the driver while operating the vehicle.

Safety Information

Please read the entire manual and follow the instructions and warnings carefully. Failure to do so can cause serious damage and/or injury, including loss of life. Be sure to obey all applicable local traffic and motor vehicle regulations as it pertains to this product. Improper installation will void manufacturer's warranty.

USAGE

- The Rear View Camera System is designed to help the driver safely detect people and/or objects helping to avoid damage or injury. However, you the driver, must use it properly. Use of this system is not a substitute for safe, proper or legal driving.
- Never back up while looking at the monitor alone. You should always check behind and around the vehicle when backing up, in the same way as you would if the vehicle did not have the Rear View Camera System. If you back up while looking only at the monitor, you may cause damage or injury. Always back up slowly.
- The Rear View Camera System is not intended for use during extensive back-up maneuvers or backing into cross traffic or pedestrian walkways.
- Please, always remember, the area displayed by the Rear View Camera System is limited. It does not display the entire panorama that is behind you.

Safety Information

INSTALLATION

- Electric shock or product malfunction may occur if this product is installed incorrectly.
- Use this product within the voltage range specified. Failure to do so can cause electronic shock or product malfunction.
- Take special care when cleaning the monitor.
- Make sure to firmly affix the product before use.
- If smoke or a burning smell is detected, disconnect the system immediately.
- Where the power cable may touch a metal case, cover the cable with a friction tape. A short circuit or disconnected wire may cause a fire.
- While installing the Rear View System be careful with the wire positioning in order to avoid wire damage.
- The Rear View System should only be used when the vehicle is in reverse.
- Do not watch movies or operate the monitor while driving; as it may cause an accident.
- Do not install the monitor where it may obstruct drivers view or obstruct an air bag device.
- Dropping the unit may cause possible mechanical failure.

Safety Information

If you have questions about this product, contact:

Customer Service:
Rear View Safety
1797 Atlantic Avenue
Brooklyn, NY 11233
Tel: 1.800.764.1028

IN NO EVENT SHALL SELLER OR MANUFACTURER BE
LIABLE FOR ANY DIRECT OR CONSEQUENTIAL DAMAGES OF
ANY NATURE, OR LOSSES OR EXPENSES RESULTING FROM
ANY DEFECTIVE PRODUCT OR THE USE OF ANY PRODUCT.



Before You Begin Installation

Before drilling please check that no cable or wiring is on the other side of the wall. Please clamp all wires securely to reduce the possibility of them being damaged while vehicle is in use. Keep all cables away from hot or moving parts and electrical noisy components.

We recommend doing a benchmark test before installation to insure that all components are working properly.

Step 1: Choose the monitor and camera locations.

Step 2: Install all cables in vehicle, when necessary a 0.8 (20mm) hole should be drilled for passing camera cable through vehicles walls. Install split grommets where applicable.

Step 3: Once all cables and wiring have been properly routed, perform a system function test by temporarily connecting the system. If the system seems to not be operating properly see troubleshooting (page 22).

Installation Guide

Camera

1. Attach camera bracket close to rear marker lights, centered on vehicle.
2. Attach camera to bracket using screws provided and adjust the angle.

Cable

1. Be sure to position the cable properly. The aviation camera cable uses aircraft grade connectors which means the camera cable can be exposed to all weather elements, do not run the cable over sharp edges, do not kink the cable and keep away from HOT and rotating parts.
2. Fasten all cable and secure all excess cable.

Monitor

1. The Mirror Monitor attaches to the existing rear view mirror in vehicle with the pressurized clips on the back of the monitor.
2. Attach monitor to existing mirror, and adjust mounting angle to allow optimum driver viewing comfort. (see figure 1.1 on page 12).

Wiring Camera & Monitor

- When installing a ONE (1) camera setup, connect camera extension cable from the rear view camera to port labeled "backup" (most systems port #3) Connect red 12V+ wire to ignition power source and black wire 12V- to chassis ground. Do not use white and yellow wires.
- The blue wire is the REVERSE trigger wire. In typical rear-view installations, connecting this wire to the vehicle's backup light circuit will activate the rear-view image whenever the vehicle shifts into reverse.
- Before drilling, be sure no cable or wire is on the other side.
- Feed as much cable as possible into vehicle & clamp securely. This reduces the possibility of cable being hooked or snagged.
- Camera: Drill a 20mm (0.8in) diameter hole into vehicle body near the camera and bracket. Insert camera cable into vehicle (be careful not to kink cable) and fit grommet into hole. Apply sealant around grommet to increase resistance to water penetration. Connect camera to the camera extension cable which runs inside the vehicle.
- The camera system can be wired to be powered "ON" the entire time the vehicle is on. This is typical in RV and some commercial applications.
- The camera and monitor can always be activated by manually pushing the power button on monitor. This is in addition to utilizing the positive triggers.

Note: If connecting power directly to battery, the camera is always ON and therefore can drain battery. Therefore it is recommended to connect power to an ignition switched accessory power source.

Wiring Camera & Monitor

- When installing a TWO (2) camera setup, use ports #3 and #2 and use positive triggers Blue and White.
 - There is a built-in voltage regulator for our systems which can handle 9-32 volts. Real consumption is 10 to 30 Volts.
 - When installing all THREE (3) cameras, use all three ports and connect all positive triggers to appropriate connections.
 - To activate grid lines connect the blue trigger to a power source. If you want the grid lines to be on when reversing, connect the blue trigger to reverse power. If you want the grid lines to be on all the time connect the blue trigger to a constant power.
-
- ◆ To automatically have camera and monitor turn ON when vehicle activates, simply twist BLUE positive trigger 12V+ to Red Power line 12V+ and wire to ignition power which can be an accessory switch/fuse line and black wire 12V- to chassis ground.
 - ◆ Infrared technology built into camera IRs are activated automatically according to the lighting conditions.
 - ◆ When using the positive trigger functions (blue, yellow & white wires) each trigger function needs to work on a separate 12V+ source i.e. the Yellow and White wires can be wired to a turn signal circuit etc.
 - ◆ Grid lines function can be turned on/off by manually from menu. (See page 14)

Installation Diagram

Figure 1.1

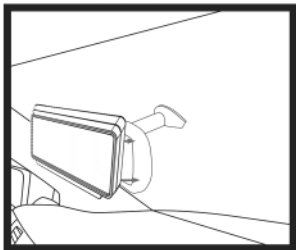

Figure 1.2

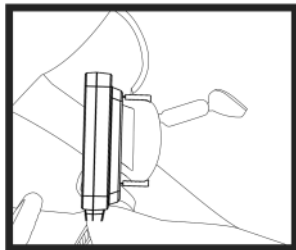
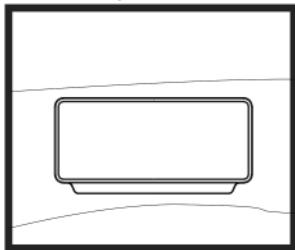
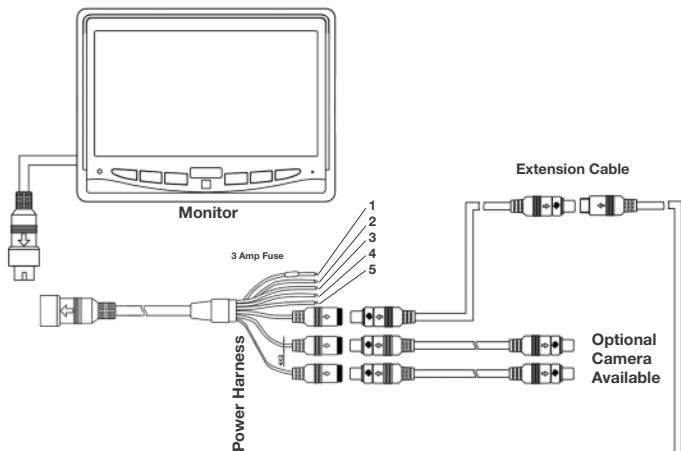

Figure 1.3



Installing the Monitor



1. DC12V-24V
2. Ground
3. Port #3 (blue)
4. Port #2 (brown)
5. Port #1 (white)

Optional Camera Available

Monitor Operation

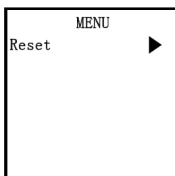
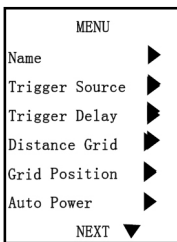
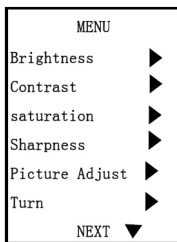

- Brightness, Contrast, Saturation, Sharpness: Adjust image properties
- Picture Adjust: Stretch image horizontally (right/left and left/right)
- Turn: Toggle between mirror/normal image on each individual channel
- Name: Change name of teach individual channel
- Trigger Delay: Adjust time delay on each trigger
- Trigger Source: Toggle channel destination for each trigger
- Distance Grid: Toggle which channel distance grid lines will display on
- Grid Position: Adjust position of distance grid lines
- Auto Power: On: Monitor will automatically turn on when powered. Off: Monitor will only turn on when triggered. Auto: Monitor will follow previous state.
- Reset: Reset settings to factory default

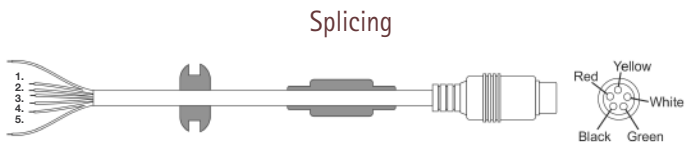

- 1. Red - Power (+)**
- 2. Yellow - Video**
- 3. Green - Mirror / Normal Imaging**
- 4. White - Audio**
- 5. Black - Ground (-)**

Positioning

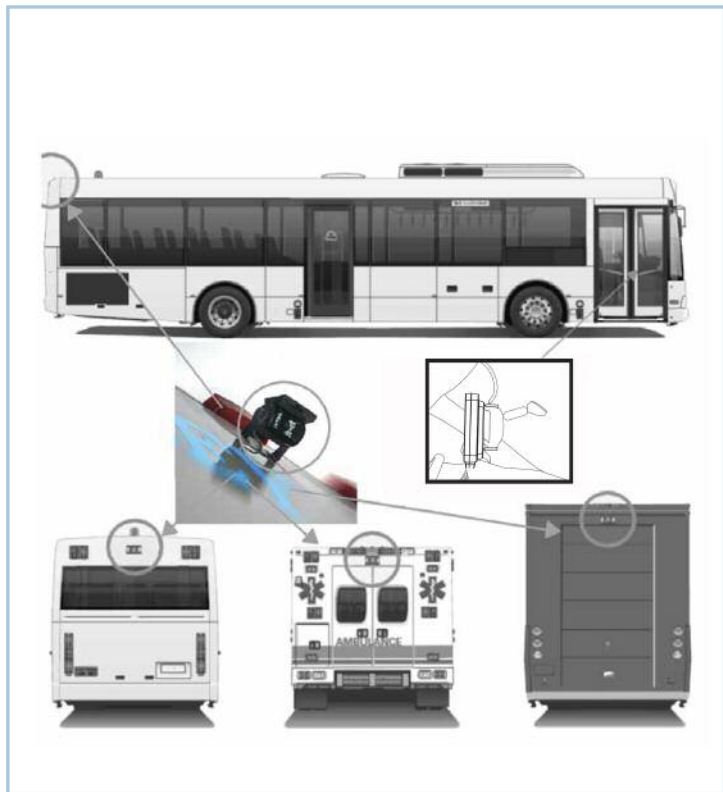

Monitor Dimensions

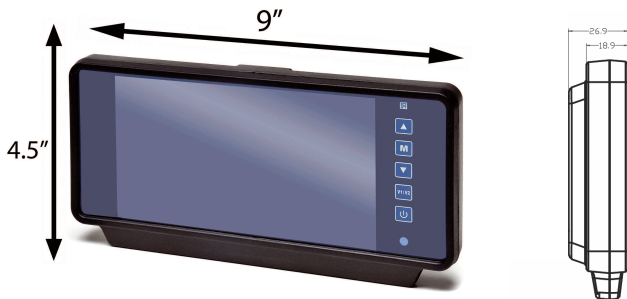

Replacement Monitor



Clip-On Monitor

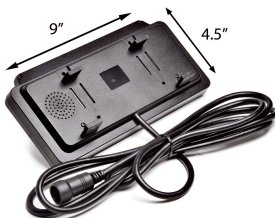

Monitor Specifications

TFT LCD Digital Monitor	
Screen Size	Digital 7"
Dot Resolution	800H x 3 (RGB) x 480V
Display Format	16:9
Display Brightness	400cd/m ²
Viewing Angle	90° min
Video Input	3 channel
Video Source	1Vp-p, 75Ω
Power Supply	DC 9V-32V
Power Consumption	5W
Operating Temperature	-10°C - +65° C
Video System	Auto NTSC/PAL
Overall Dimensions	9"L x 4.5"H x 1"D
Weight	400G
Impact Rating	5G
Dot Pitch	0.192H x 0.1805V
Sync System	Internal

Troubleshooting

Monitor Displays Blue Screen & Displays No Signal

- Check to ensure that the connection to the camera is tight.
 - Verify camera cable is plugged into port labeled Backup Camera
 - Verify that the blue positive trigger on power harness is put to power 12v+.
- If the problem still persists, verify that alternate ports work. If alternate ports do not work, remove Blue Trigger wire from 12V+ and select alternate channels.

Monitor Will Not Power-Up (no backlight on power button)

- Check fuse
- Check 12v+ to monitor
- Check ground connection

No Image On Screen

- Verify camera is on correct camera input
- Verify cable is connected to monitor
- Verify camera is connected to cable
- Connect known working camera and cable to monitor.
- Verify Blue trigger is receiving power

Audio on Camera

- Verify chosen camera has audio
- Verify volume setting
- Confirm that the Blue audio trigger is connected to 12v+

REAR VIEW SAFETY

One Year Warranty

Rear View Safety Inc. warrants this product against material defects for a period of one year from date of purchase. We reserve the right to repair or replace any such defective unit at our sole discretion.

Rear View Safety Inc. is not responsible for a defect in the system as a result of misuse, improper installation, damage or mis-handling of the electronic components. Rear View Safety Inc. is not responsible for consequential damages of any kind.

This warranty is void if: defects in materials or workmanship or damages result from repairs or alterations which have been made or attempted by others or the unauthorized use of nonconforming parts; the damage is due to normalware and tear, this damage is due to abuse, improper maintenance, neglect or accident: or the damage is do to use of the Rear View Safety Inc. system after partial failure or use with improper accessories.

Warranty Performance

DURING THE ABOVE WARRANTY PERIOD, SHOULD YOUR REAR VIEW SAFETY PRODUCT EXHIBIT A DEFECT IN MATERIAL OR WORKMANSHIP, SUCH DEFECT WILL BE REPAIRED WHEN THE COMPLETE REAR VIEW SAFETY INC. PRODUCT IS RETURNED, POSTAGE PREPAID AND INSURED, TO REAR VIEW SAFETY INC. OTHER THAN THE POSTAGE AND INSURANCE REQUIREMENT, NO CHARGE WILL BE MADE FOR REPAIRS COVERED BY THIS WARRANTY.

Warranty Disclaimers

NO WARRANTY, ORAL OR WRITTEN, EXPRESSED OR IMPLIED, OTHER THE ABOVE WARRANTY IS MADE WITH REGARD TO THIS REAR VIEW SAFETY INC. REAR VIEW SAFETY INC. DISCLAIMS ANY IMPLIED WARRANTY OR MERCHANTABILITY OR FITNESS FOR A PARTICULAR USE OR PURPOSE AND ALL OTHER WARRANTIES IN NO EVENT SHALL REAR VIEW SAFETY INC. LIABLE FOR ANY INCIDENTAL, SPECIAL, CONSEQUENTIAL, OR PUNITIVE DAMAGES OR FOR ANY COSTS, ATTORNEY FEES, EXPENSES, LOSSES OR DELAYS ALLEGED TO BE AS A CONSEQUENCE OF ANY DAMAGE TO, FAILURE OF, OR DEFECT IN ANY PRODUCT INCLUDING, BUT NOT LIMITED TO, ANY CLAIMS FOR LOSS OF PROFITS

Disclaimer

Rear View Safety and/or its affiliates does not guarantee or promise that the user of our systems will not be in/part of an accident or otherwise not collide with an object and/or person. Our systems are not a substitute for careful and cautious driving or for the consistent adherence to all applicable traffic laws and motor vehicle safety regulations. The Rear View Safety products are not a substitute for rearview mirrors or for any other motor vehicle equipment mandated by law. Our camera systems have a limited field of vision and do not provide a comprehensive view of the rear or side area of the vehicle. Always make sure to look around your vehicle and use your mirrors to confirm rearward clearance and that your vehicle can maneuver safely. Rear View Safety and/or its affiliates shall have no responsibility or liability for damage and/or injury resulting from accidents occurring with vehicles having some of Rear View Safety products installed and Rear View Safety and/or its affiliates, the manufacturer, distributor and seller shall not be liable for any injury, loss or damage, incidental or consequential, arising out of the use or intended use of the product. In no event shall Rear View Safety and/or its affiliates have any liability for any losses (whether direct or indirect, in contract, tort or otherwise) incurred in connection with the systems, including but not limited to damaged property, personal injury and/or loss of life. Neither shall Rear View Safety and/or its affiliates have any responsibility for any decision, action or inaction taken by any person in reliance on Rear View Safety systems, or for any delays, inaccuracies and/or errors in connection with our systems functions.



**If you have any questions
about this product, contact:**

**Rear View Safety, Inc.
1797 Atlantic Avenue
Brooklyn, NY 11233
800.764.1028**

**BETTER CAMERAS. BETTER SERVICE.
IT'S OUR GUARANTEE.**

